















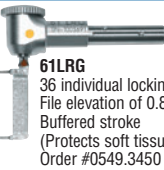

INTRAFlex LUX 2

Standard Low-Speed Operative System

Clinical Application	Speed At Bur Up To	Head	Contra Angle Attachment	Coupler	
Dentin reduction, gross caries removal, general cavity preparation, porcelain adjustments, C & B preps (bevels & margins), cut retention grooves	2320LN 35,000 rpm	 68LH* 1:1 Transmission Latch head Order #0540.2040	 2320LN Transmission 1:1 Speed range-up to 35,000 rpm Order #0535.6180	 1390 MULTIflex LUX Coupler Anti-retraction valve KaVo fiber optic tubing Midwest Insight System Star ColoRight System Order #0553.1390	
	2307LN 13,000 rpm	 80LD* 1:1 Transmission Friction grip Order #0540.1830			
Same as above Increases torque	2320LN 17,500 rpm	 67LH* 2:1 Reduction Latch head Order #0540.8460	 2307LN Reduction 2.7:1 Speed range-up to 13,000 rpm Order #0535.6190	 465LRN MULTIflex LUX Coupler Spray Regulator Anti Retraction Valve Light Bulb in Coupler KaVo tubings for LCM illuminators Standard 6 hole tubings Order #0553.1550	
	2307LN 6,500 rpm				
	2329LN 2,500 rpm				 61LRG 36 individual locking positions File elevation of 0.8mm Buffered stroke (Protects soft tissue) Order #0549.3450
Pin drilling & placement, deep caries removal, amalgam polishing, root canal treatment with latch type files	2307LN 1,300 rpm	 62LDN* 10:1 Reduction Latch head Order #0540.8310	 2329LN Reduction 7.4:1 Speed range-up to 5,000 rpm Order #0535.6200	 459AN MULTIflex LUX Coupler Speed Control Forward/Reverse Anti Retraction Valve Light Bulb in Coupler KaVo tubings for LCM illuminators Standard 6 hole tubings Order #0553.1590	
Prophylaxis, cups and brushes, amalgam polishing	2329LN 500 rpm				
Prophylaxis, cups and brushes, amalgam polishing	2307LN 6,500 rpm	 31LR 2:1 Reduction For screw in or snap-on cups Order #0549.3380		 5 hole fiber optic tubing	
	2329LN 2,500 rpm				 6 hole tubing

*Push button auto chuck

**To reach an AXIS Dental product specialist call toll free 888-654-2947.

Ask about other INTRA heads for INTRAFlex LUX 2 System

Specialty Intermediate Speed Handpiece

Clinical Application	Speed At Bur Up To	Contra Angle Handpiece	Coupler
For precision cutting, retention grooves, porcelain adjustments, crown & bridge work, cavity prep finishing, occlusal adjustments.	140,000 rpm	 2325LN Increase 1:4 Fixed head/friction grip Push button auto chuck Order #0535.6210	  6 hole tubing

Straight Low-Speed Handpiece

Clinical Application	Speed At Bur Up To	Straight Handpiece	Coupler
Chairside trimming, denture adjustment	13,000 rpm	 2313LN Reduction 2.7:1 Order #0535.6220	  6 hole tubing